



RESPIREX™



Instructions for use of Powered Respirator Protective Suit PRPS



Table Of Contents

Introduction	Pg 1
General Information	Pg 2
Limitations of Use	Pg 3
Storage	Pg 4
Suit label	Pg 5
Preparation for use	Pg 6
Indicator lights and warnings,	Pg 9
Donning procedure.	Pg 10
Decontamination procedures	Pg 15
Doffing procedure	Pg 15
Emergency self doffing procedure	Pg 17
Disposal of Tychem®TK.	Pg 18
Battery disposal.	Pg 18
Filter disposal.	Pg 18
Sizing	Pg 19
Permeation Performance	Pg 20
Physical Properties Of Tychem®TK. Material	Pg 21
EU Declaration of Conformity	Pg 22

Introduction

The Respirex powered respirator protective suit (PRPS) is intended for use by emergency response personnel after a chemical or biological incident. The suit should only be used after a process of detection, identification and monitoring which has established the potential hazard. A typical example of application for the suit would be to protect personnel decontaminating casualties following such an incident. **It is important to note that the suit is NOT appropriate for use in environments where the chemical or biological hazard is unknown.**

The product is type approved to a manufacturers specification, RILS0002, based upon the requirements for a limited use type 1b-ET gas-tight chemical protective suit as detailed in EN943-2:2002 and satisfies the Basic Health and Safety Requirements, ANNEX II of the PPE Regulation (EU) 2016/425. The specification for a full facemask has been replaced by that for a visor. Note: the total mass of the PRPS exceeds that stipulated for a normal EN12941:1998 filtering device. For changes to manufacturer's designed duration refer to 3M Jupiter™ AFU user instructions, 3M Ref QX-3800-1080-8. The system has additionally been tested against chemical warfare (CW) agents for permeation resistance and for respiratory protection against standard military challenges, similar to those defined in the NATO Respirator Triptych D/103:1991.

General Information

The suit is manufactured from Tychem®TK., a high-performance chemical protective clothing material developed by DuPont for protection against gaseous, liquid and solid chemicals.

The suit is fitted with a 3M Jupiter™ Air Filter Unit (AFU). The AFU is battery powered and worn on a waist belt within the suit. The AFU draws air through externally mounted filters and feeds it through a breathing tube into the head space. A remote warning and indicator device, featuring three coloured lights, is mounted at chin level in the head space and connected to the AFU via a cable.

During operational use the AFU must be fitted with 3M TH3 A2B2E2K2P R filters, enhanced to provide additional protection against chemical and biological warfare agents (3M Ref. JFR-85-CE). The filters, when used in conjunction with the 3M Jupiter™ AFU as part of an approved system, conform to the European standard EN12941:1998. Please refer to the instructions for use supplied with the 3M Jupiter™ AFU for limitations, storage, cleaning instructions etc.

Garment features include:

- Large semi-rigid visor bonded to the suit.
- Four exhalation valves fitted to the rear of the suit.
- Integral safety boots with steel toe-caps and mid-soles.
- Dual glove system consisting of a laminated inner glove having good chemical resistance (Kemblok™) bonded to a outer Neoprene glove affording protection against mechanical risks as well as having some degree of chemical resistance. The gloves are fitted to the suit by means of the Respirix locking cone and grommet system.
- Optional re-hydration facility
- Exterior attachment point for distress signal unit

The PRPS is designed as a limited-use garment, i.e. designed to be worn until chemical contamination has occurred and disposal is required.

A full hygienic cleaning service using specialist equipment is provided by Respirix.

Limitations of Use

Failure to follow all instructions on the use of this product may adversely affect the wearer's health, may lead to severe illness or permanent disability or even death.

Only for use by trained competent personnel.

PRPS suits should not be used in areas immediately dangerous to life or health (IDLH).

Tychem®TK. fabric is designed specifically for limited-use garments. Excessive flexing or folding can lead to weaknesses in the structure of the fabric which may have an adverse effect on the chemical resistance offered by the suit. However, extensive operational use of garments manufactured from Tychem®TK. has demonstrated its durability beyond that of a single-use fabric. Continuity of performance for multiple use can be assured by a regular programme of inspection and re-certification.

If the suit is heavily contaminated or mechanically damaged in any way it **MUST NOT** be used and **MUST** be disposed of.

Caution: Tychem®TK. is a non-breathable material and the wearer's body temperature will rise whilst wearing the suit, particularly during periods of intense physical activity. Wherever possible operational procedures should be planned to minimise the risk of heat stress occurring. Use of the optional re-hydration facility is recommended.

Leave the contaminated area immediately and remove the suit if:

- a) Any part of the system becomes damaged e.g. tears or punctures in the suit.
- b) Airflow into the suit decreases or stops, or visor misting occurs.
- c) Breathing becomes difficult.
- d) Dizziness or other distress occurs.
- e) You taste or smell contaminants or an irritation occurs.
- f) An alarm condition occurs.

Never modify or alter this product.

Tychem®TK. meets the resistance to ignition requirements of EN943-1:2015 but nonetheless should not be exposed to flame.

Tychem®TK. does not have any anti-static treatment or properties and should not be worn in flammable or potentially explosive environments.

The usable temperature range of the ensemble is -5°C to +40°C <90% humidity. Users should note that resistance to permeation by chemicals varies with temperature.

Continuous contact with certain chemicals can adversely effect the field of vision and protection offered by the visor. If the end-user notices any discolouration of the visor the suit **MUST NOT** be used.

NEVER change any component parts associated with the suit in a contaminated area.

Materials used in the construction of the system are not known to cause allergic reactions to the majority of individuals. The system contains no components made from natural rubber latex.

This equipment is not to be used in oxygen-deficient environments, e.g. confined spaces. For further information refer to the instructions for the 3M Jupiter™ AFU.

For any enquiries please contact the Respirex customer services department on Tel : +44(0) 1737 778600 or Fax : +44(0) 1737 779441.

® DuPont's registered trademark.

Storage

To prevent damage occurring during storage the system is supplied in a plastic container. Suits should always be stored in a clean and dry condition at ambient temperature. If being stored for long periods of time the suits should be kept out of direct sunlight.

Based upon real time use, the PRPS system has a minimum shelf life of five years. Additional research on Tychem®TK material would suggest a possible shelf life of up to ten years.

In order to maintain the level of protection offered, care should be taken to minimize the risk of damage occurring to the PRPS suits during transportation between work areas. It is recommended that all PRPS suits are transported in a suitably sized rigid container resistant to penetration by sharp objects, abrasive surfaces, chemicals, oils, solvents etc.

For the purposes of disposal a sealable hazbag is included with the system. For further information on disposal refer to page 18.

Suit label

1. Manufacturer of garment; Respirex International Ltd.
2. Manufacturer's Model number
3. Manufacturer's Style number
4. Serial number.
5. Material of Manufacture.
6. Manufacturer's Order No.
7. Customer Name.
8. Date of manufacture;
Day/Month/Year.
9. Flask Pictogram denoting protection against chemical hazards
10. Garment Size

Size	Chest cms (inches)	Height cms (inches)
S	86-94 (34"-37")	152-165 (5'-5'5")
M	94-102 (37"-40")	163-175 (5'4"-5'9")
L	102-112 (40"-44")	173-185 (5'8"-6'1")
XL	109-124 (43"-49")	180-196 (5'11"-6'5")
XXL	122-135 (48"-53")	188-203 (6'2"-6'8")

11. "Open Book Pictogram"; wearer must refer to the "Instructions for use" for further information.
12. Five care pictograms indicating that clothing is not suitable for cleaning and reuse.
 - **Pictogram 1** Do not machine wash
 - **Pictogram 2** Do not bleach
 - **Pictogram 3** Do not iron
 - **Pictogram 4** Do not machine dry
 - **Pictogram 5** Do not dry clean



Preparation for use

The suit is supplied in a sealed bag, fully tested and in full working order. Nevertheless it is advisable for the following checks to be carried out in a clean area prior to donning the suit:

1. Visually inspect the suit for any damage that may reduce the level of protection; pay particular attention to the seam areas and gloves.
2. Check the suit is free from contamination both externally and internally.
3. Check vision through the visor is not impaired by scratches or heavy scuff marks.
4. Check the zip operates correctly and the pull tag is in good condition.
5. Verify the breathing tube and remote warning device are connected to the AFU (fig. 2).

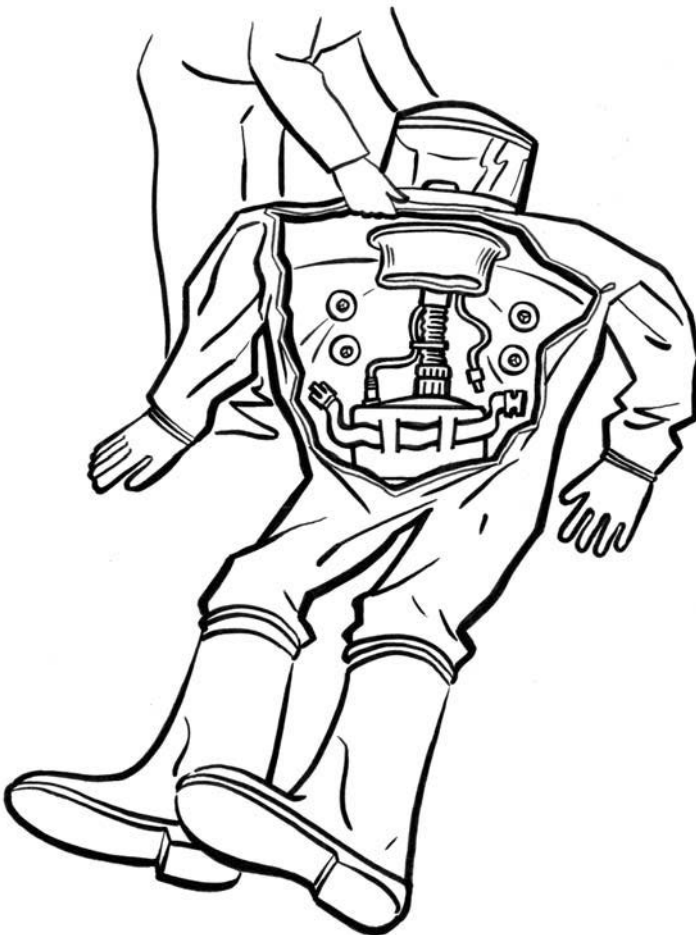

Fig.1

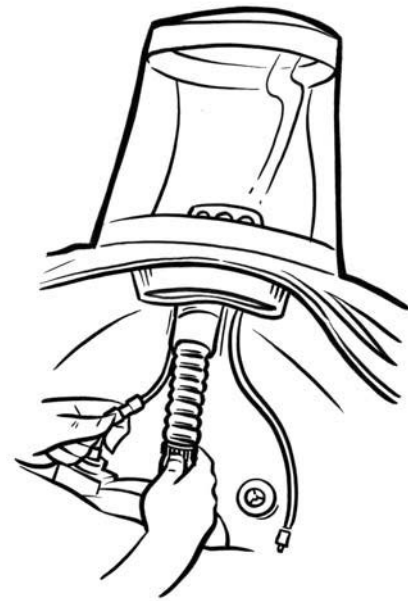

Fig.2

6. Fit the battery to the AFU (fig 3).
7. Switch on the AFU. The AFU will beep, the lights on the remote warning device will cycle for a short time, then the green light will remain illuminated (fig 4). At this point the 60 minute timer begins.

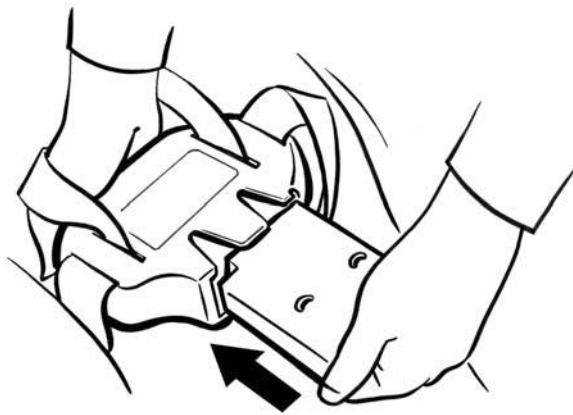

Fig.3

Note: Lights as viewed from exterior of suit

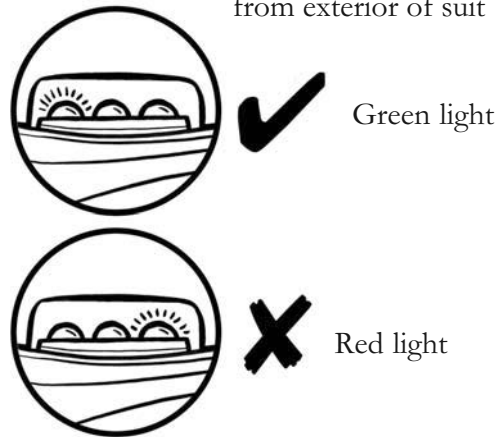

Fig.4

8. Remove the small plastic screw caps and fit the two filters to the suit (figs. 5 & 6). **Important: The clear plastic filter lids should remain in place whilst the filters are in use.**

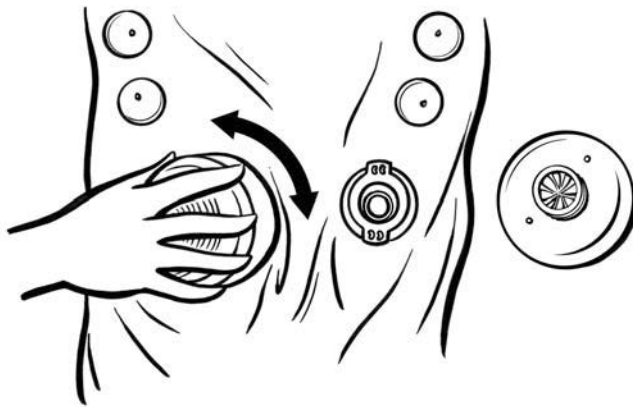

Fig.5

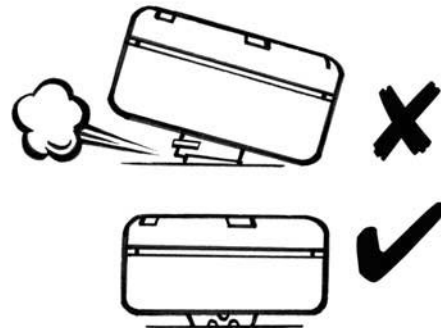

Fig.6

9. An optional airflow check can be carried out as follows.
 - I. Remove the breathing tube from the air filter unit.
 - II. Insert the airflow indicator tube into the air filter unit outlet.
 - III. Hold the AFU so that the tube is vertical and at eye level.
 - IV. Verify the ball has risen above the black line on the tube (fig 7).
 - V. Remove the airflow indicator tube and refit the breathing tube.

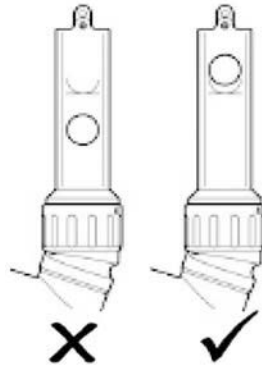

Fig.7

10. To check warnings block the breathing tube outlet by putting a hand into the suit headspace and covering the open end of the tube with a flat hand (fig.8). Ensure that after a short time the buzzer begins to beep and the red light begins to flash.
11. Remove hand from the outlet. The red light will go out, all three lights will cycle for a short time then the green light will remain illuminated (fig.9).
12. The suit is now ready for use.

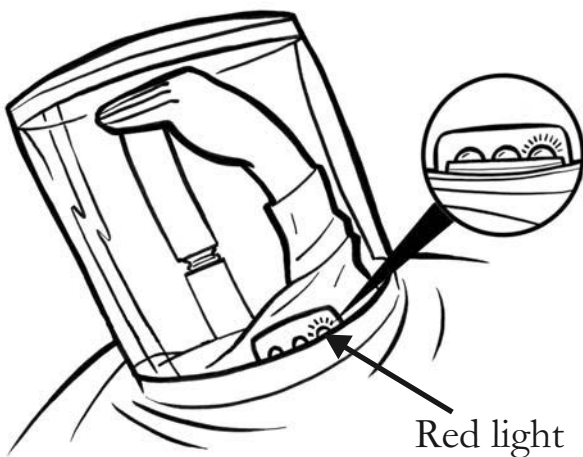

Fig.8

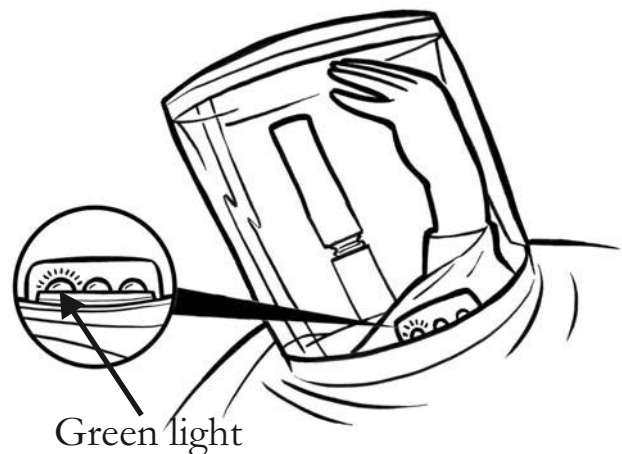

Fig.9

At this point the AFU can be switched off until the user is ready to don the suit. When the AFU is restarted the lights will cycle for a short time, then the green light will remain illuminated. The 60 minute timer will re-set.

Indicator lights and warnings,

- Throughout normal operation the green light will remain illuminated.
- 60 minutes after switching on the AFU the amber light will illuminate intermittently and the buzzer will beep for 10 seconds.
- After 75 minutes (additional 15 minutes) the amber light will remain illuminated and the buzzer will beep for 10 seconds.
- In an alarm condition the red light will flash and the buzzer will beep. This indicates either a low air flow or a low battery.

Donning procedure

Make sure the suit has been visually inspected and is suitable for the intended use.

Underclothing should be worn beneath the suit. As a minimum, a short sleeve shirt and long trousers or “long underwear” are recommended. Remove all personal affects which may result in damage to the suit (e.g. pens, badges, jewelry etc.). Remove footwear, the suit is fitted with it’s own integral ‘HAZMAX’ safety boots. It is advisable to tuck trousers into socks to make donning of suit legs and boots easier.

Entry to the suit is made via an opening at the front that is sealed by a gas-tight zip fastener protected by overlapping flaps with a velcro strip.

It is good practice for an assistant to help the wearer don and doff the suit. This makes the process easier and quicker, and will help to avoid stumbling or tripping which may result in personal injury or damage to the suit. **NB.** The suit must **always** be donned in a clean uncontaminated area.

Follow these steps in donning the suit:

1. If applicable, rinse and fill the re-hydration pack. Don the re-hydration pack and adjust straps until comfortable (fig. 10).
2. Whilst seated, place both legs into the suit (fig. 11).



Fig.10



Fig.11

3. Stand up and with the dressing assistant supporting the weight of the AFU at the rear of the suit, fasten the internal waist belt securely (fig. 12). If necessary adjust the belt until comfortable.
4. Lift the suit up above waist level and connect the drinking tube that runs from the headspace to the tube on the re-hydration pack (figs. 13 & 14).



Fig.12



Fig.13



Fig.14

5. If required a peak-less safety helmet with chin strap can be now donned (fig 15). **NB** Owing to the non-breathable nature of the laminate gloves attached to the suit it is not uncommon for the wearer's hands to moisten due to sweating. For this reason it is recommended that cotton gloves are worn to absorb sweat and to assist with donning and doffing procedure (fig. 16).



Fig.15



Fig.16

6. The dressing assistant should now switch on the AFU to ensure that breathing air is supplied to the wearer (fig. 17). **NB NEVER** attempt to wear a PRPS without switching on the AFU and ensuring the green light is permanently illuminated (see indicator lights and warnings).
7. Place both arms into the suit (fig.18).

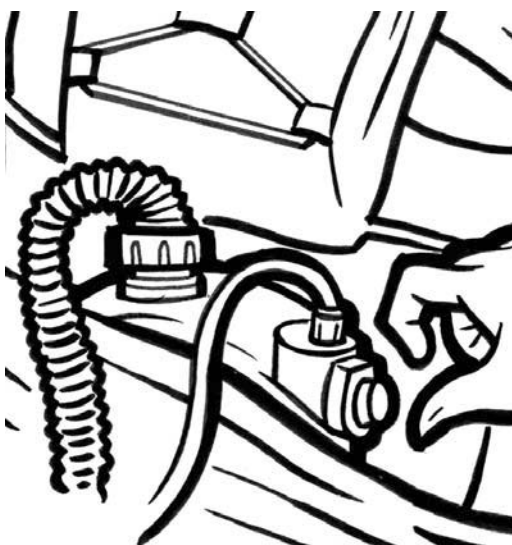

Fig.17



Fig.18

8. The wearer should duck forwards and the assistant should pull the hood of the suit over the head (figs.19 & 20). **NB** It may be necessary to re-adjust the helmet after this stage. Ensure that the knitted neck seal sits evenly around the wearer's neck.



Fig.19



Fig.20

9. With the wearer's arms in an outstretched position the assistant should fully fasten the zipper across the chest, (fig.21).
10. Seal down the zip flaps evenly to the suit, trying to leave a minimum of gaps and ridges for the possible ingress of spray or splash (fig.22). Note: when sealing down the upper flap you may find it easier to achieve a smooth seal by working from the centre outwards.

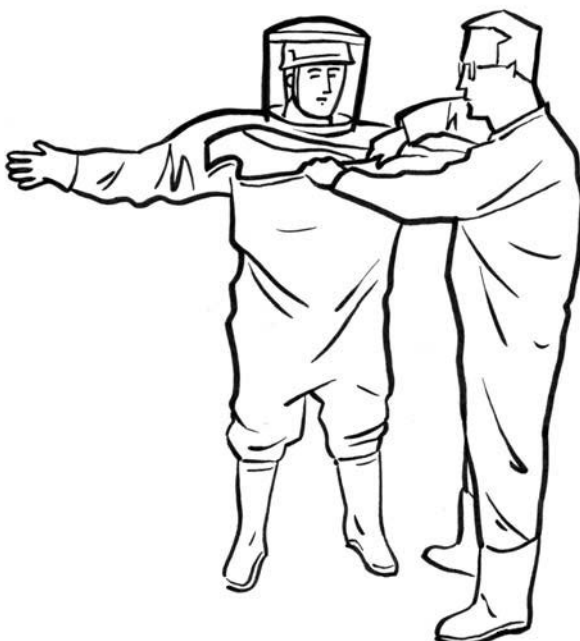

Fig.21



Fig.22

11. When fully donned the suit should appear as in figs.23 & 24.



Fig.23



Fig.24

Decontamination procedures

Do not remove the PRPS, remove the filters or turn off the Jupiter™ AFU until you have vacated the contaminated area.

Preliminary washing by means of a high pressure shower will remove most of the contaminant from the outer surface of the suit sufficient to allow the wearer to undress from the garment.

Should you not have access to a high pressure shower, the suit can be sprayed with copious quantities of water and a suitable detergent and neutralizer for a minimum period of 5 minutes.

Doffing procedure

1. After preliminary decontamination procedures – lay the hazbag supplied with the suit on the ground, open end facing upwards. The wearer should stand in the open end of the hazbag in preparation for doffing (fig. 25).



Fig.25



Fig.26

2. With the wearer's arms in an outstretched position the dressing assistant should break the velcro seal on the outer zip flaps and fully open the gas-tight zip across the chest (fig. 26).
3. Wearers' should now withdraw their arms from the sleeves of the suit and unfasten both the waist belt attached to the AFU and the chin strap of the peak-less safety helmet (if worn). After unfastening the waist belt the wearer's arms should be crossed over the chest (fig. 27).

- The wearer should duck forwards so that the dressing assistant can lift the hood of the suit up and over the wearer's head. **Note:** It is likely that if a safety helmet is being worn this will automatically come away from the wearer's head and remain in the head space of the suit. The helmet can be recovered from the suit on completion of the doffing procedure.



Fig.27



Fig.28

- If wearing the suit in combination with a re-hydration pack this should now be disconnected from the drinking tube attached to the suit.
- The dressing assistant should carefully lower the suit to boot level (fig. 28), and the wearer can now step out of the suit avoiding contact its exterior (fig 29).



Fig.29



Fig.30

7. The dressing assistant should now switch off the AFU and unscrew the externally mounted filters for safe disposal (re-seal filters with the original plastic caps).
8. If necessary the peak-less safety helmet can now be recovered from the head space of the suit.
9. The suit, including attached AFU, can now be sealed in the hazbag using the plastic tie provided (fig. 30). **Ensure all relevant information is entered onto the hazbag tag before returning used systems to Respirex.**

Emergency self doffing procedure

1. Withdraw your right arm from the suit sleeve and push against the back of the zip at the pull tag end.
2. With your left hand unseal the outer velcro flap fastening and undo the zip.
3. Undo the AFU belt and unfasten the helmet chin strap (if worn).
4. Exit the suit.

IMPORTANT: Respirex will only be able to clean, service, sanitize, retest and repack used PRPS systems once there is documentary confirmation that the equipment is chemically and biologically safe to handle.

Such confirmation should include:

- The serial numbers of the suit/AFU used.
- Identification of the incident that the equipment has been used at
- A written, signed statement from a competent source that the equipment has not been exposed to any chemical or biological contamination or that any such contamination has been completely neutralized and removed.

Disposal of Tychem®TK.

Whilst the exact composition of the fabric is confidential to the manufacturer, it is known that Tychem TK. consists of polymers which do not contain halogens in their structural formula. After use, Tychem TK. can either be incinerated without harm to the environment, or can be buried in a responsible manner. It is important to note that the nature of any chemical contamination on the garment should be taken into account when deciding on the best method of disposal.

Battery disposal

The 3M Jupiter™ AFU is powered by a single-use lithium/thionyl chloride. For all further battery information, including disposal, refer to 3M Jupiter™ AFU user instructions, 3M Ref QX-3800-1080-8.

Filter disposal

In use, the 3M JFR-85-CE filter canister will absorb and retain any particulate contamination that is present in the immediate environment. Used filter canisters are potential reservoirs of any contamination that is present and should be disposed of accordingly. Disposal of used filters should be undertaken in accordance with local health and safety and environmental regulations. For further information refer to 3M user instructions, 3M Ref CV-0005-1801-5.

Sizing

The following pictograms designate the range of height & chest sizes suitable for specific sizes of PRPS suit, check your body measurements and select the correct size of suit. Body measurements in cm (inch). **Warning:** Incorrect size selection could lead to a reduced level of protection.

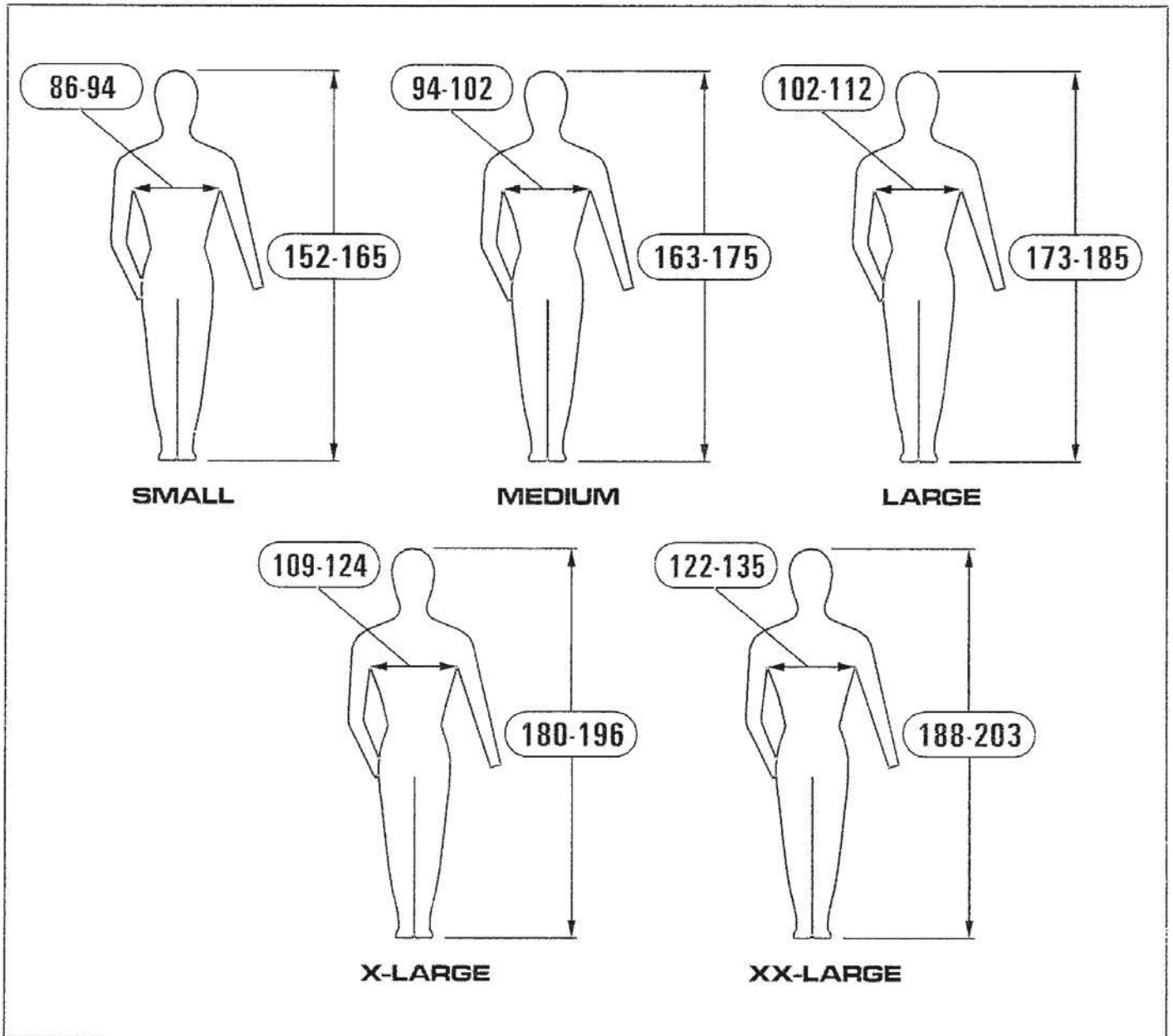

Size	Body Height	Chest Girth
S	152 - 165 (5' 0" - 5' 5")	86-94(34" - 37")
M	163 - 175 (5' 4" - 5' 9")	94-102(37" - 40")
L	173 - 185 (5' 8" - 6' 1")	102-112(40" - 44")
XL	180 - 196 (5' 11" - 6' 5")	109-124(43" - 49")
XXL	188 - 203 (6' 2" - 6' 8")	122-135(48" - 53")

Permeation Performance

The following test results indicate resistance to permeation against each of the 15 liquid chemicals in the standardised test battery ASTM F1001-99a.

All tests carried out under laboratory conditions by independent accredited laboratories in accordance with EN ISO 6529: 2001 unless otherwise stated.

Table shows average breakthrough times in minutes.

Chemical	Tychem®TK. Material	Kemblok™/Neoprene Glove Combination	Visor
Acetone	>480	>480	>480
Acetonitrile	>480	>480	>480
Carbon Disulphide	>480	>480	>480
Dichloromethane	>480	>480	>480
Diethylamine	>480	>480	>480
Dimethylformamide	>480	>480	>480
Ethyl Acetate	>480	>480	>480
Hexane	>480	>480	>480
Methanol	>480	>480	>480
Nitrobenzene	>480	>480	>480
Sodium Hydroxide 50%	>480	>480	>480
Sulphuric Acid 93%	>480	>480	>480
Tetrachloroethylene	>480	>480	>480
Tetrahydrofuran	>480	>480	>480
Toluene	>480	>480	>480

Physical Properties Of Tychem®TK. Material

Property	Tested In Accordance With	Minimum Class Required for Manufacturers Specification	Class Achieved
Abrasion resistance	EN14325 : 2004 clause 4.4.1/ 4.4.2	4	6
Tensile strength	EN14325 : 2004 clause 4.9	3	4
Flex cracking resistance	EN14325 : 2004 Clause 4.5	1	1
Flex cracking resistance at low temperatures -30°C	EN14325 : 2004 Clause 4.6	2	3
Trapezoidal tear resistance	EN14325 : 2004 clause 4.7	3	6
Puncture resistance	EN14325 : 2004 clause 4.10	2	2
Seam strength	EN14325 : 2004 clause 5.5	5	5
Resistance to ignition	EN14325 : 2004 clause 4.14	No part shall ignite or continue to burn on removal from flame	pass



RESPIREX™

EU DECLARATION OF CONFORMITY

RESPIREX INTERNATIONAL LTD
Unit F Kingsfield Business Centre,
Philanthropic Road,
Redhill,
Surrey RH1 4DP
United Kingdom

Declares that the PPE described hereafter:

Respirex Powered Respirator Protective Suit (known as PRPS)

Product code: CPS97V06S**L**Z41, where S** are the two options for the sleeve terminations and L** are the two options available for the leg terminations. This Garment must be used with the compatible 3M Jupiter™ powered air respirator (3M ref. no: JP-ER-02) and two A2B2E2K2P R (CW-enabled) filters (3M ref. no: JFR-85-CE).

Is in conformity with the provisions of Regulation (EU) 2016/425 and is identical to the PPE which is subject to EU certificate of conformity No CE 703141 and is subject to the procedure set out in Module D of Regulation (EU) 2016/425, which both certificates are issued under the supervision of the approved body:

BSI
Davy Avenue, Knowhill,
Milton Keynes. MK5 8PP, United Kingdom
EC Notified Body No 0086

These garments are described in the manufacturer's technical file TF067, Issue C.

Done at: RESPIREX, Redhill, Surrey, on 1 October 2018

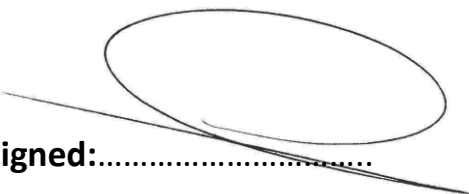
Signed:.....

Mark Bellas Simpson (Managing Director)



Registered in England No. 592506 VAT No. GB 115 0754 43
Directors: M. Bellas Simpson A.C.A. D.G. Mackie P.J. Wilson

Respirex International Limited
Unit F, Kingsfield Business Centre,
Philanthropic Road, Redhill,
Surrey RH1 4DP.
Tel: +44 (0) 1737 778600
Fax: +44 (0) 1737 779441
Email: info@respirex.co.uk
Web: www.respirex.co.uk

EU DECLARATION OF CONFORMITY

This Declaration of Conformity, issued under the sole responsibility of the manufacturer

3M United Kingdom PLC of 3M Centre, Cain Road, Bracknell, Berkshire, RG12 8HT, UK

hereby declaring the following Personal Protective Equipment (PPE)

Product Model: 3M Jupiter JP-ER-02 Air Filter Unit

is/are in conformity with the provisions of the following European Regulations and/or Directives

EMC (Electromagnetic compatibility) Directive

The 3M Jupiter JP-ER-02 Air Filter Unit is/are in conformity with the provisions of EMC Directive 2014/30/EU and with the National Standard transposing the harmonised European Standard Number(s):

EN 55011:2007 – Industrial, scientific and medical radio-frequency equipment – Electromagnetic disturbance characteristics – Limits and methods of measurement

EN 61000-4-2:1995 – Electrostatic discharge immunity test

EN 61000-4-3:2002 – Radiated, radio-frequency, electromagnetic field immunity test with levels for assessing immunity as specified by:

EN 61000-6-2:2005 – Immunity for industrial environments



Signed by: M Thomas

European Regulatory Manager
Personal Safety Division
3M United Kingdom PLC

Date: 21st November 2018



Replacing the exhalation valve diaphragm

Please Note: The method for replacing the exhalation valve detailed below supersedes that outlined in the original user instructions supplied with the garment .

1. Using a torque driver with a 'T8' Torx bit, loosen and remove the screw from the centre of the exhalation valve, then remove the cap.
2. Carefully slide the diaphragm up the central spigot and remove from the exhalation valve body.
3. Check that there is no dust, debris or contamination of any kind in the exhalation valve body.
4. Carefully slide a new diaphragm down the central spigot until it rests evenly on the valve body. Ensure the diaphragm is correctly orientated with the ridged side uppermost (see Fig 2).
5. Replace the exhalation valve cap and ensure the two locating channels engage with the locating keys on either side of the valve body. **Note:** When correctly located, the valve cap will not rotate independently on the valve body.
6. Replace the centre screw, turn by hand two times to engage the thread with the valve body, then fully tighten using a torque driver set to 23 ± 2 cNm.

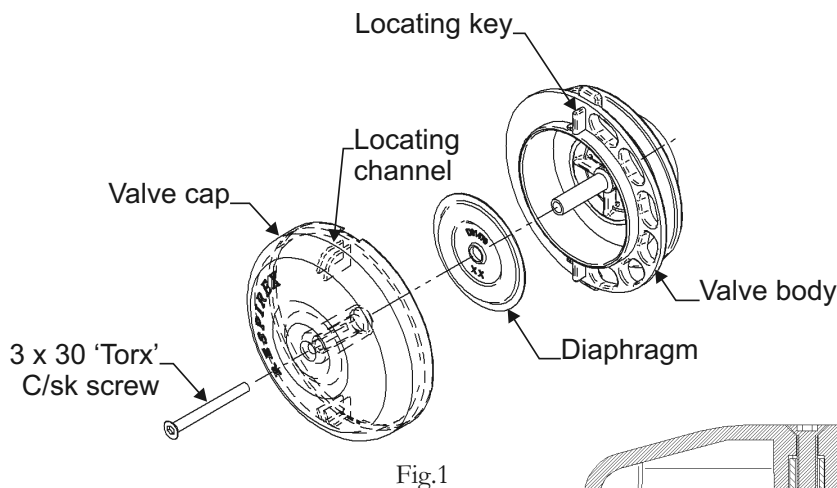

Fig.1

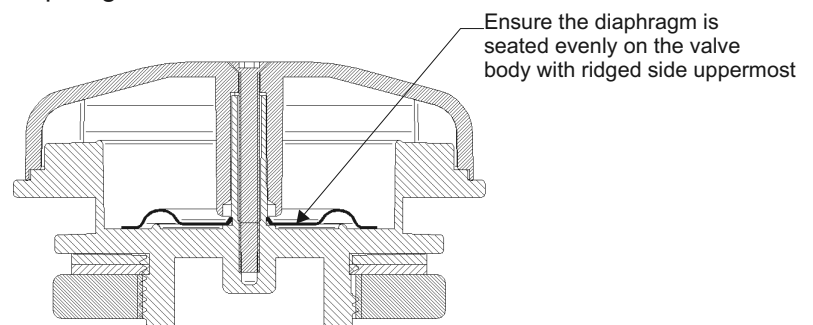

Fig.2

RESPIREX INTERNATIONAL LTD,

Unit F Kingsfield Business Centre,

Philanthropic Road,

Redhill,

Surrey. RH1 4DP

ENGLAND.

Tel. 44 (0) 1737 778600

Fax. 44(0) 1737 779441

Email. info@respirex.co.uk

Module B and Module D type:

Examination By : **BSI**

Davy Avenue, Knowhill

Milton Keynes MK5 8PP

ENGLAND

Notified Body No. **0086**